

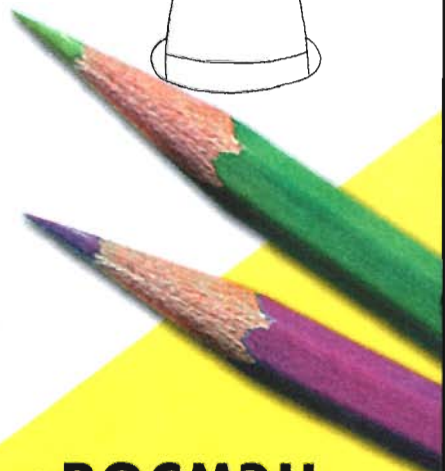

РИСУЕМ

СКАЗОЧНЫХ

ГЕРОЕВ

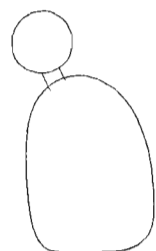
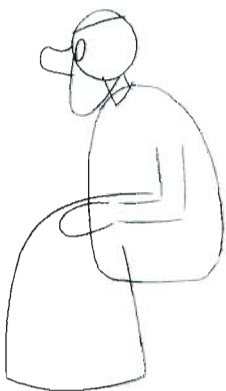

• РОСМЭН •

КАК НАРИСОВАТЬ ПРИВИДЕНИЕ

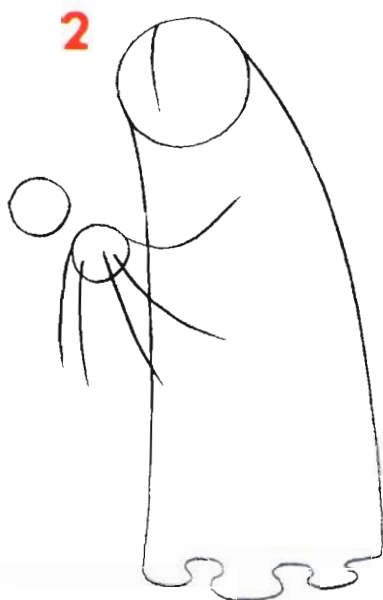
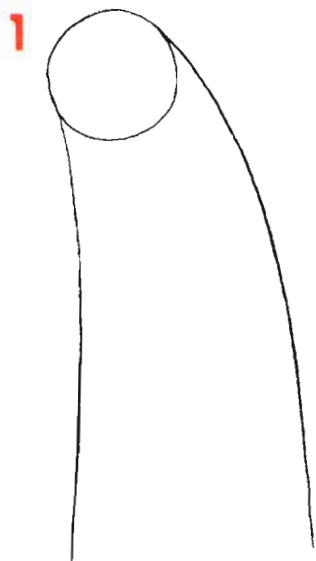

КАК НАРИСОВАТЬ РЫЦАРЯ

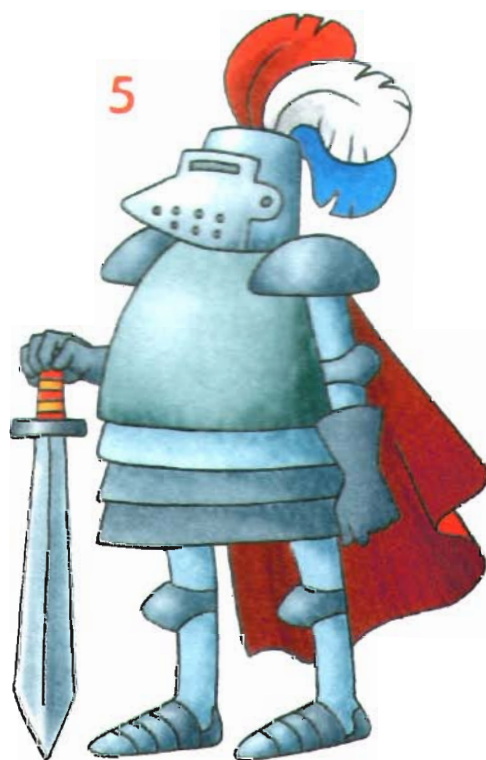
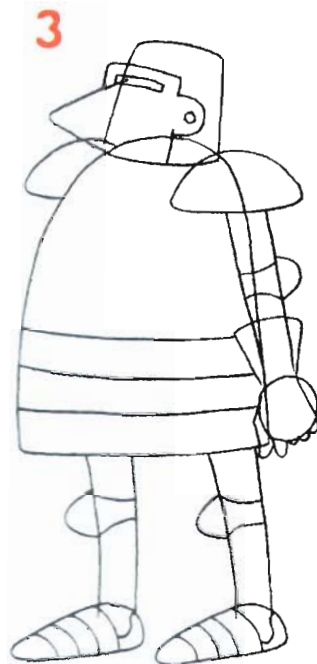
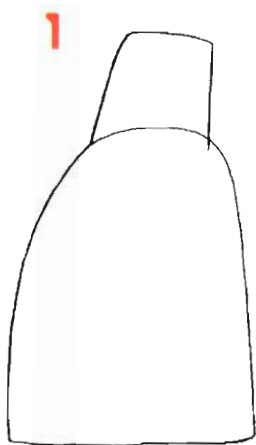

КАК НАРИСОВАТЬ БАБУ-ЯГУ

1

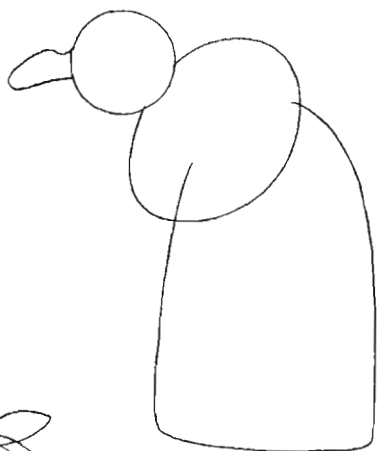

2



3



4



5



КАК НАРИСОВАТЬ РОБОТА

1

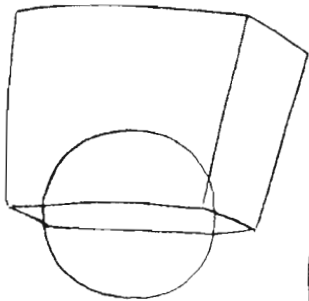

2

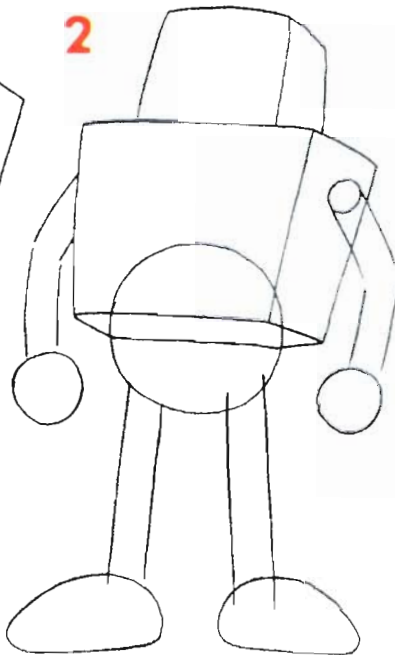

3

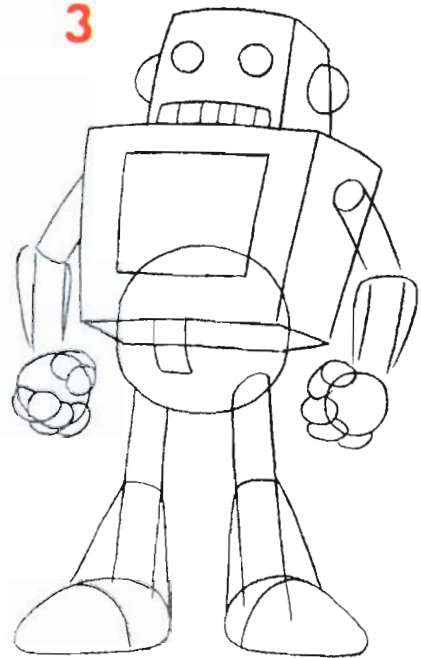

4

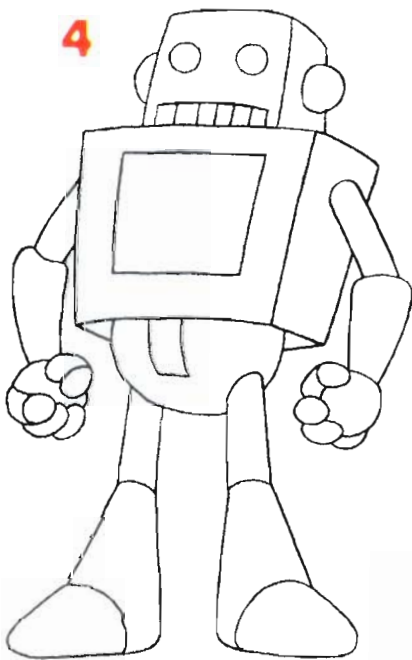

5

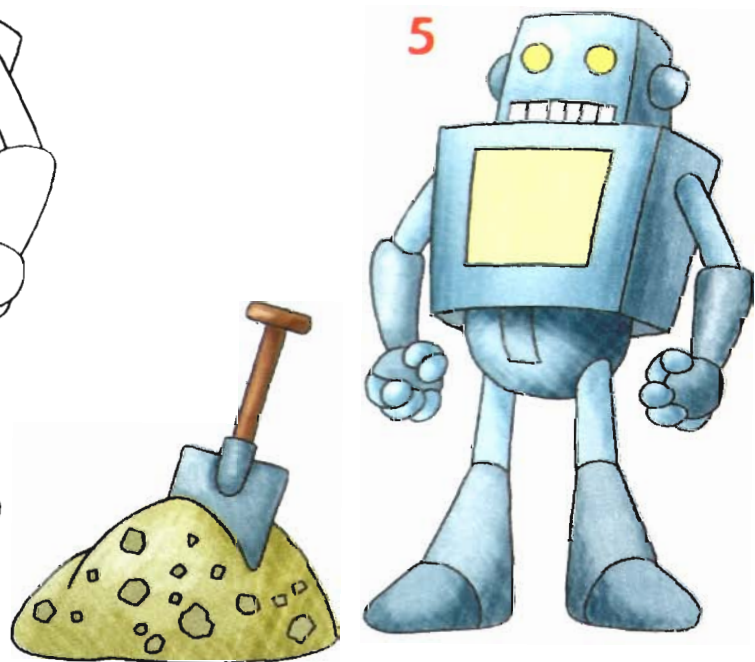

КАК НАРИСОВАТЬ ГНОМИКА

1

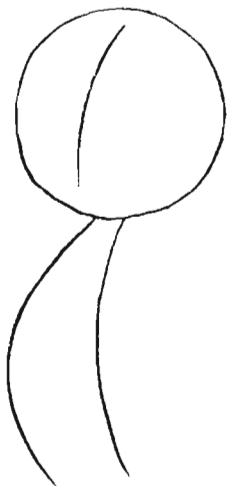

2



3



4



5



6



КАК НАРИСОВАТЬ БУРАТИНО

1

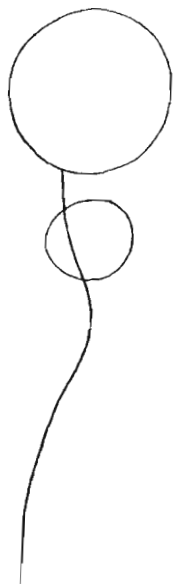

2



3



4



5



6



КАК НАРИСОВАТЬ КАРАБАСА-БАРАБАСА

1

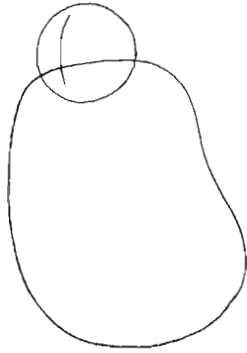

2

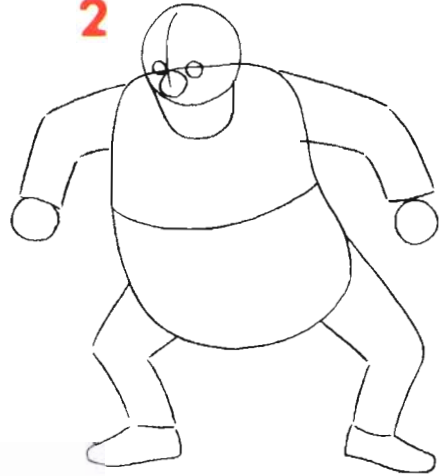

3



4



5



КАК НАРИСОВАТЬ ДРАКОНА

1

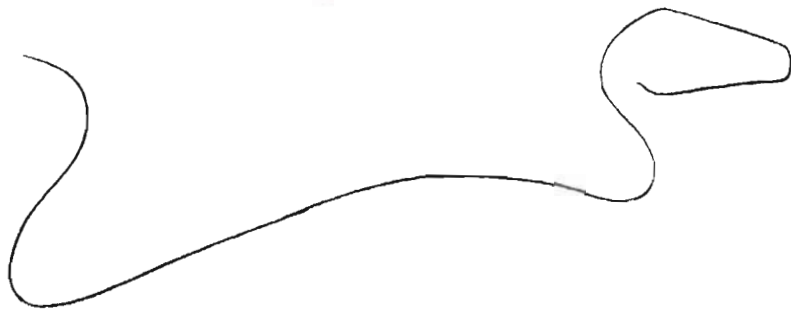

2

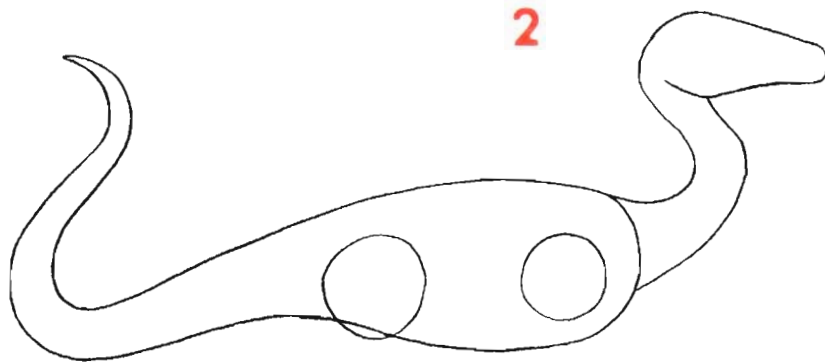

3

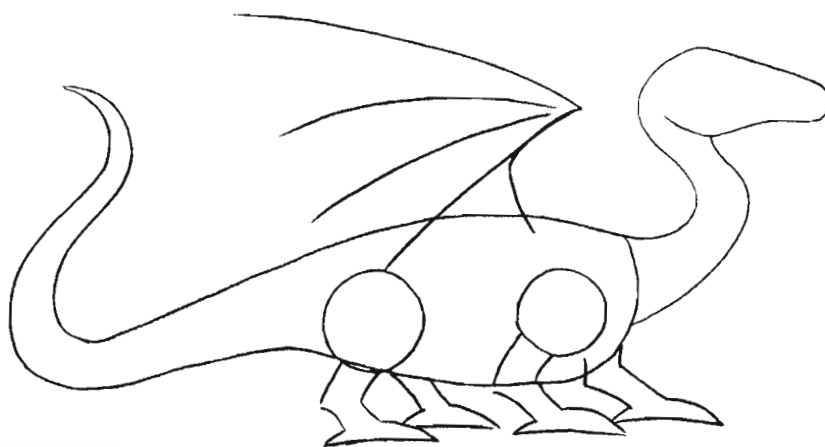

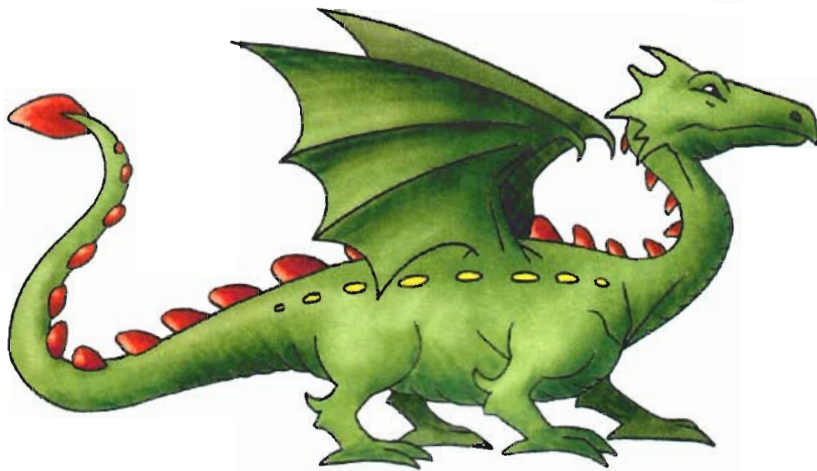
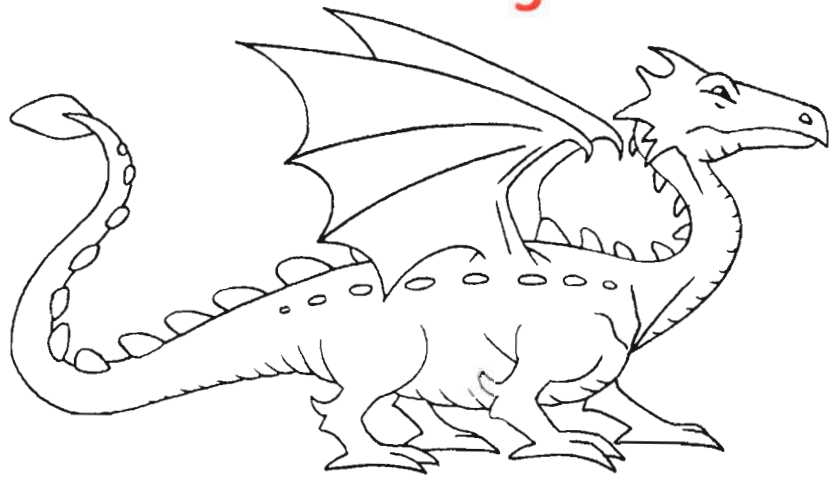

КАК НАРИСОВАТЬ КОРОЛЯ

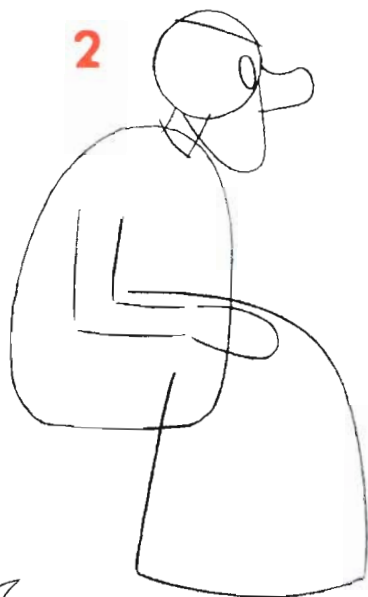
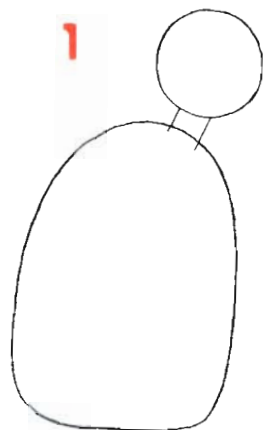

КАК НАРИСОВАТЬ ПРИНЦЕССУ

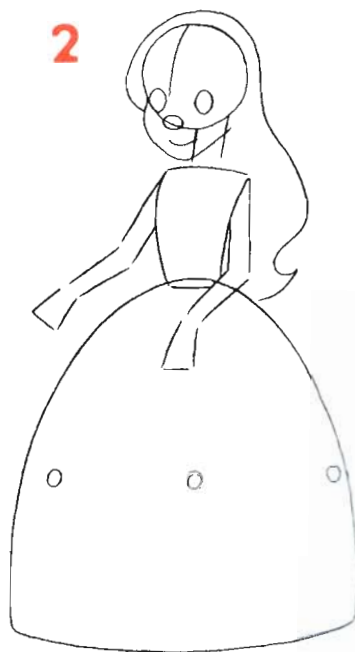
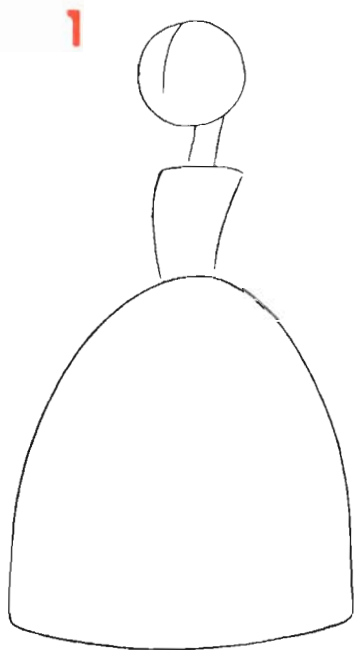

КАК НАРИСОВАТЬ КАРЛСОНА

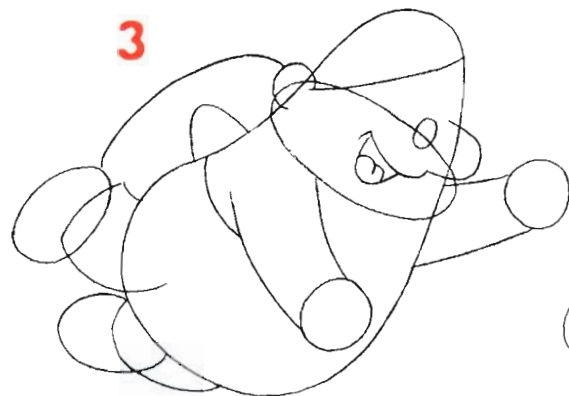
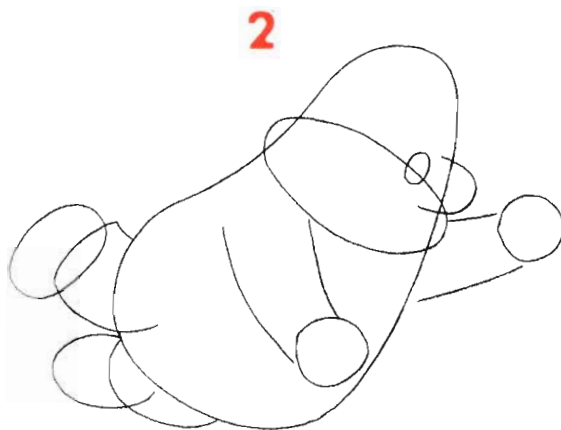
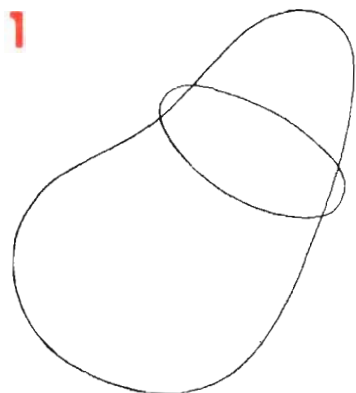

КАК НАРИСОВАТЬ РУСАЛОЧКУ

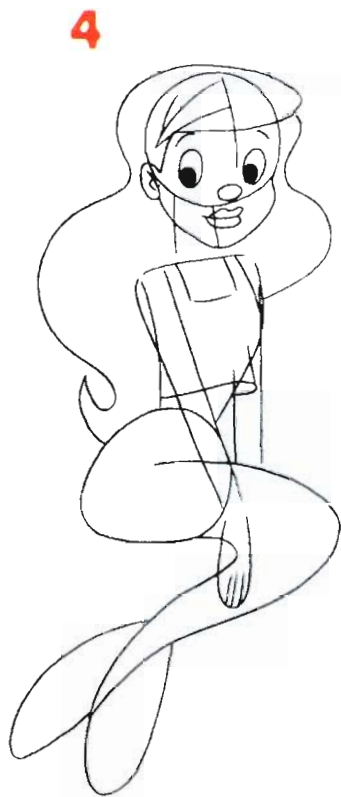
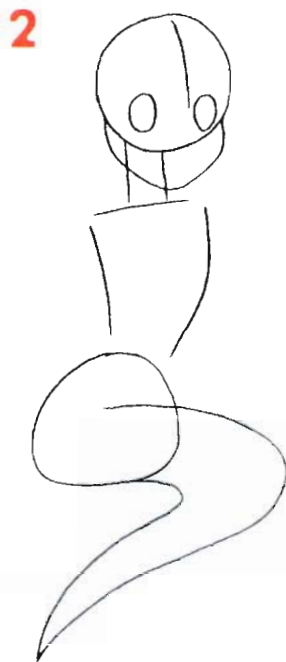
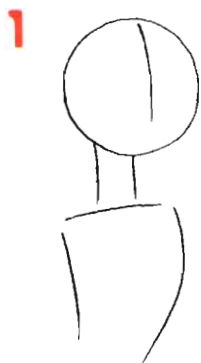

КАК НАРИСОВАТЬ ДЕДА МОРОЗА

1

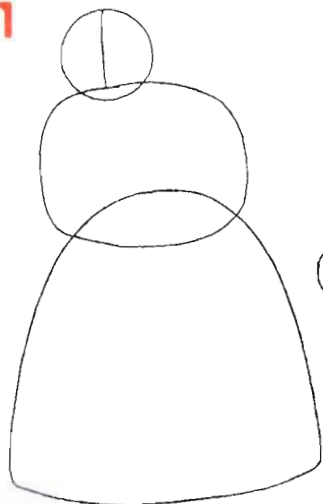

2



3



4



5



КАК НАРИСОВАТЬ СНЕГУРОЧКУ

1

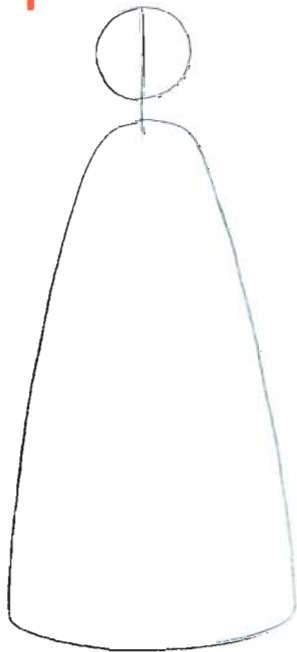

2



3



4



5



КАК НАРИСОВАТЬ ПИРАТА

